

内平开窗NPKC

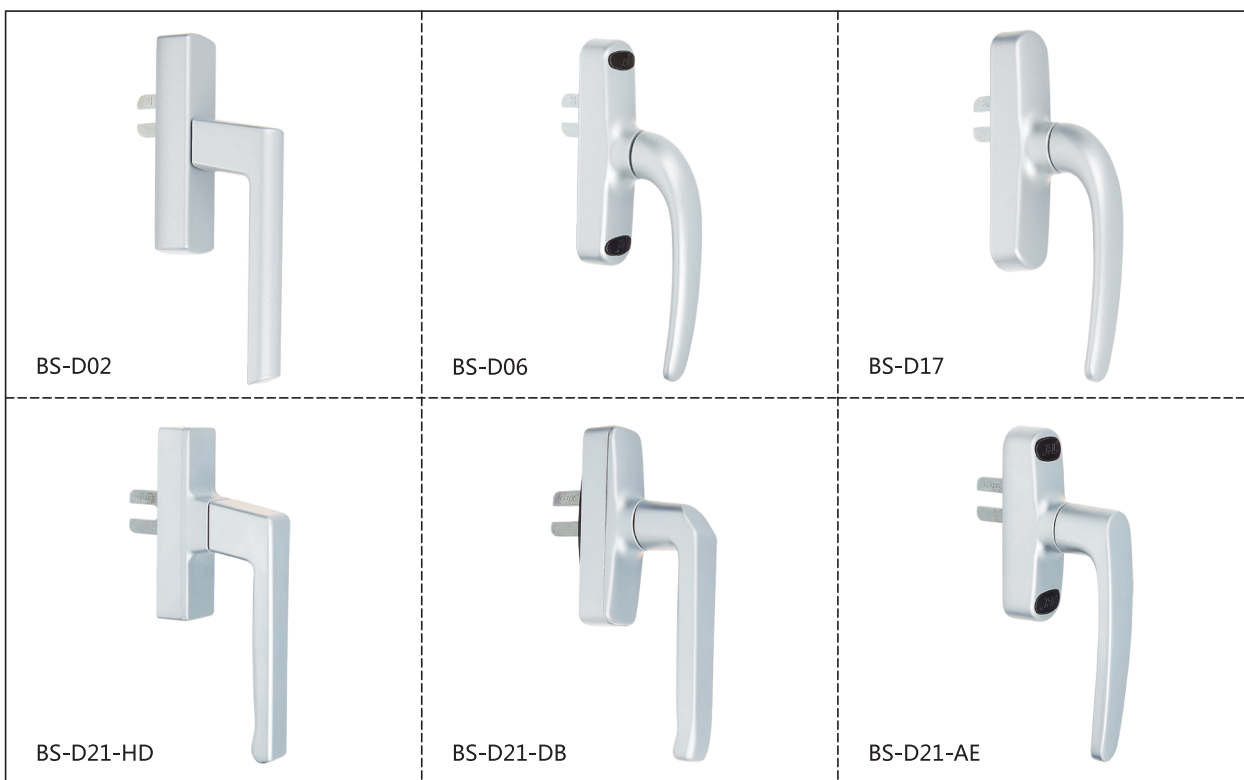

可供选择把手:



内平开五金件NPKC-01

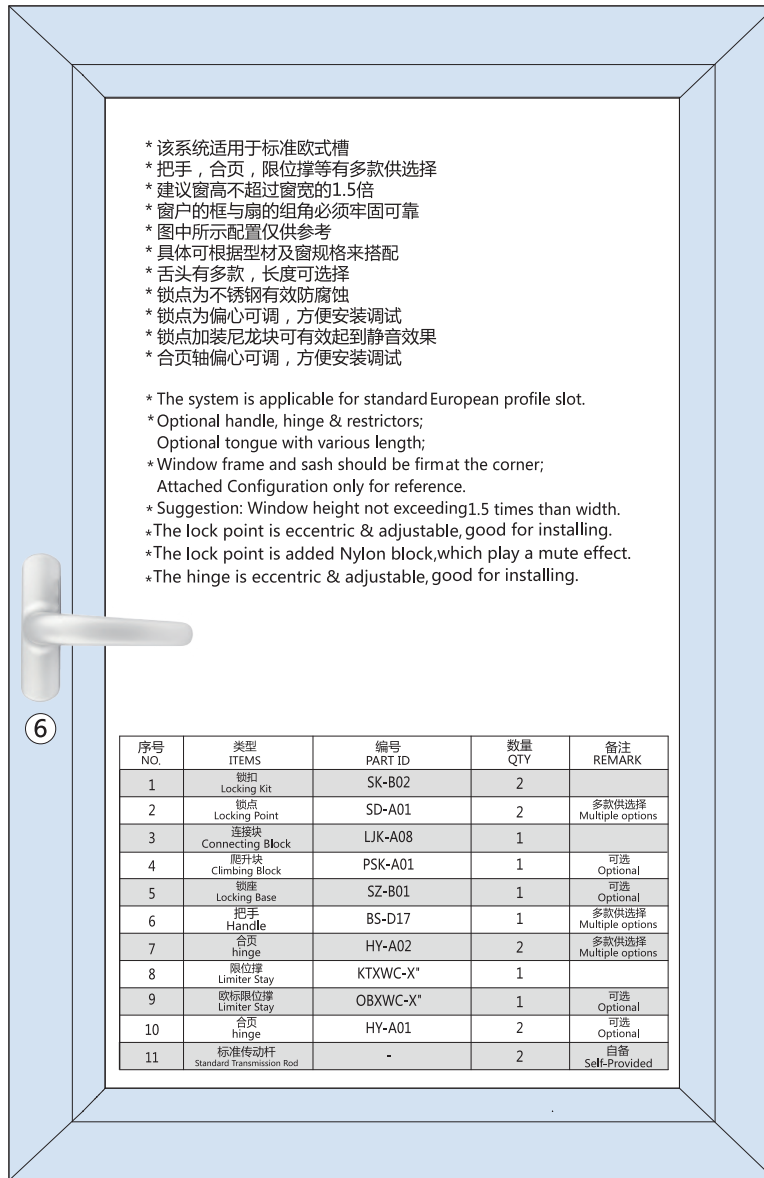
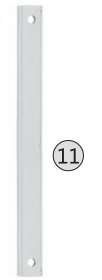
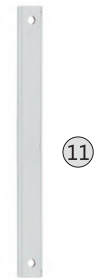
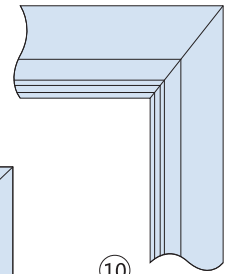
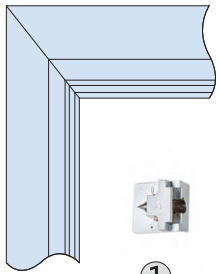
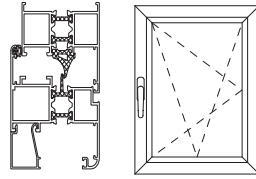

- * 该系统适用于标准欧式槽
- * 把手, 合页, 限位撑等多款供选择
- * 建议窗高不超过窗宽的1.5倍
- * 窗户的框与扇的组角必须牢固可靠
- * 图中所示配置仅供参考
- * 具体可根据型材及窗规格来搭配
- * 舌头有多款, 长度可选择
- * 锁点为不锈钢有效防腐蚀
- * 锁点为偏心可调, 方便安装调试
- * 锁点加装尼龙块可有效起到静音效果
- * 合页轴偏心可调, 方便安装调试

- * The system is applicable for standard European profile slot.
- * Optional handle, hinge & restrictors;
- Optional tongue with various length;
- * Window frame and sash should be firm at the corner;
- Attached Configuration only for reference.
- * Suggestion: Window height not exceeding 1.5 times than width.
- * The lock point is eccentric & adjustable, good for installing.
- * The lock point is added Nylon block, which play a mute effect.
- * The hinge is eccentric & adjustable, good for installing.

序号 NO.	类型 ITEMS	编号 PART ID	数量 QTY	备注 REMARK
1	锁扣 Locking Kit	SK-B02	2	
2	锁点 Locking Point	SD-A01	2	多款供选择 Multiple options
3	连接块 Connecting Block	LJK-A08	1	
4	爬升块 Climbing Block	PSK-A01	1	可选 Optional
5	锁座 Locking Base	SZ-B01	1	可选 Optional
6	把手 Handle	BS-D17	1	多款供选择 Multiple options
7	合页 hinge	HY-A02	2	多款供选择 Multiple options
8	限位撑 Limiter Stay	KTXWC-X*	1	
9	欧标限位撑 Limiter Stay	OBXWC-X*	1	可选 Optional
10	合页 hinge	HY-A01	2	可选 Optional
11	标准传动杆 Standard Transmission Rod	-	2	自备 Self-Provided

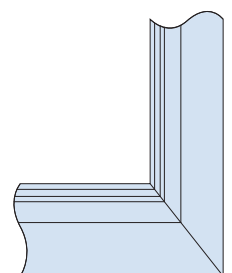
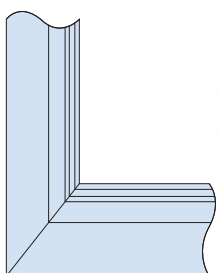
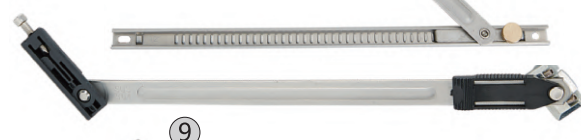

内平开五金件NPKC-02

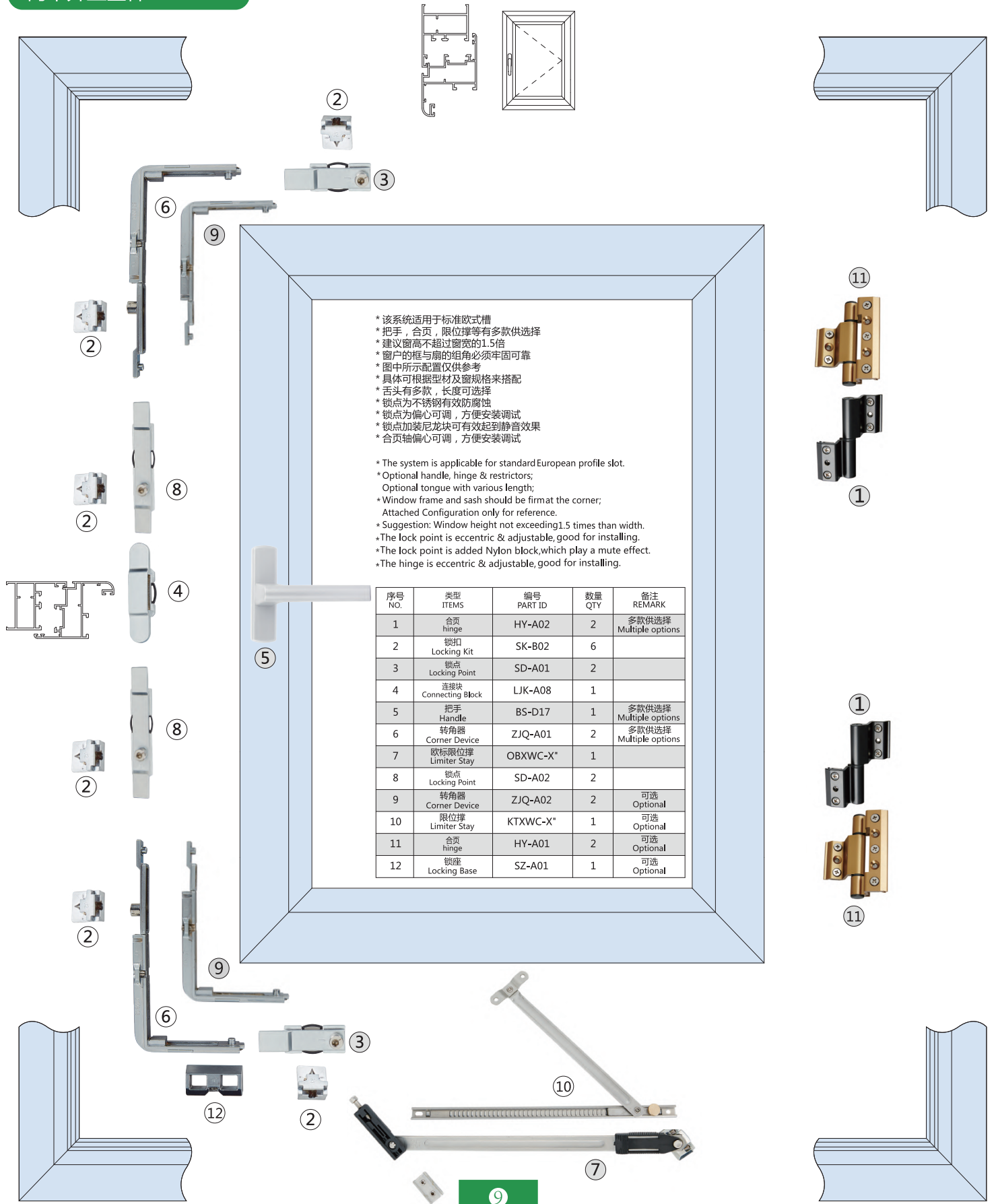

*该系统适用于标准欧式槽
 *把手, 合页, 限位撑等多款供选择
 *建议窗高不超过窗宽的1.5倍
 *窗户的框与扇的组角必须牢固可靠
 *图中所示配置仅供参考
 *具体可根据型材及窗规格来搭配
 *舌头有多款, 长度可选择
 *锁点为不锈钢有效防腐蚀
 *锁点为偏心可调, 方便安装调试
 *锁点加装尼龙块可有效起到静音效果
 *合页轴偏心可调, 方便安装调试

*The system is applicable for standard European profile slot.
 *Optional handle, hinge & restrictors;
 *Optional tongue with various length;
 *Window frame and sash should be firm at the corner;
 *Attached Configuration only for reference.
 *Suggestion: Window height not exceeding 1.5 times than width.
 *The lock point is eccentric & adjustable, good for installing.
 *The lock point is added Nylon block, which play a mute effect.
 *The hinge is eccentric & adjustable, good for installing.

序号 NO.	类型 ITEMS	编号 PART ID	数量 QTY	备注 REMARK
1	合页 hinge	HY-A02	2	多款供选择 Multiple options
2	锁扣 Locking Kit	SK-B02	6	
3	锁点 Locking Point	SD-A01	2	
4	连接块 Connecting Block	LJK-A08	1	
5	把手 Handle	BS-D17	1	多款供选择 Multiple options
6	转角器 Corner Device	ZJQ-A01	2	多款供选择 Multiple options
7	欧标限位撑 Limiter Stay	OBXWC-X*	1	
8	锁点 Locking Point	SD-A02	2	
9	转角器 Corner Device	ZJQ-A02	2	可选 Optional
10	限位撑 Limiter Stay	KTXWC-X*	1	可选 Optional
11	合页 hinge	HY-A01	2	可选 Optional
12	锁座 Locking Base	SZ-A01	1	可选 Optional

内平开五金件NPKC-03

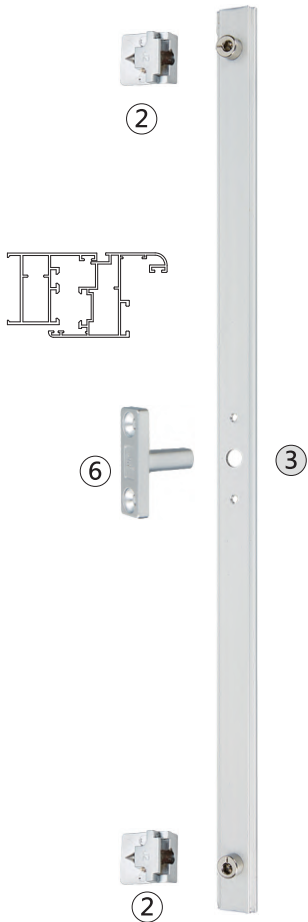
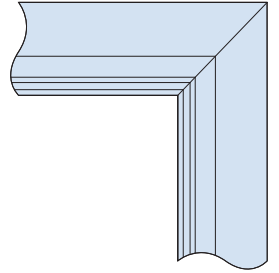
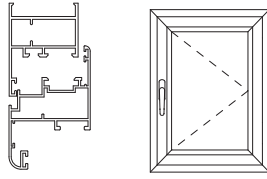
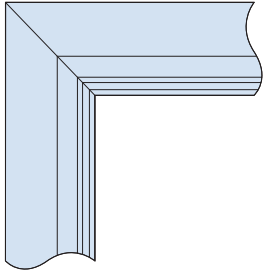

* 该系统适用于标准欧式槽
 * 把手, 合页, 限位撑等有多款供选择
 * 建议窗高不超过窗宽的1.5倍
 * 窗户的框与扇的角必须牢固可靠
 * 图中所示配置仅供参考
 * 具体可根据型材及窗规格来搭配
 * 舌头有多款, 长度可选择
 * 锁点为不锈钢有效防腐蚀
 * 锁点为偏心可调, 方便安装调试
 * 锁点加装尼龙块可有效起到静音效果
 * 合页轴偏心可调, 方便安装调试

* The system is applicable for standard European profile slot.
 * Optional handle, hinge & restrictors;
 * Optional tongue with various length;
 * Window frame and sash should be firm at the corner;
 * Attached Configuration only for reference.
 * Suggestion: Window height not exceeding 1.5 times than width.
 * The lock point is eccentric & adjustable, good for installing.
 * The lock point is added Nylon block, which play a mute effect.
 * The hinge is eccentric & adjustable, good for installing.

序号 NO.	类型 ITEMS	编号 PART ID	数量 QTY	备注 REMARK
1	欧标限位撑 Limiter Stay	OBXWC-X"	1	
2	锁扣 Locking Kit	SK-B02	2	
3	传动杆 drive link	CDG-A02	1	
4	把手 Handle	BS-D17	1	多款供选择 Multiple options
5	合页 hinge	HY-A02	2	多款供选择 Multiple options
6	T形钉 T nail	T-Z-XHX	1	
7	限位撑 Limiter Stay	KTXWC-X"	1	可选 Optional
8	合页 hinge	HY-A01	2	可选 Optional

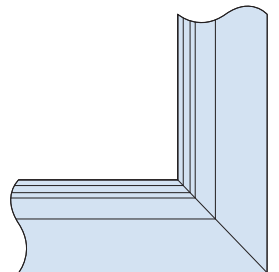
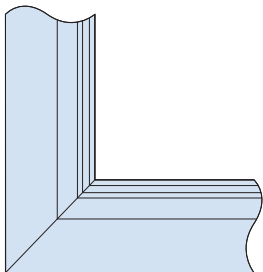

外平开五金件WPKC



可供选择把手:



外平开五金件WPKC-01

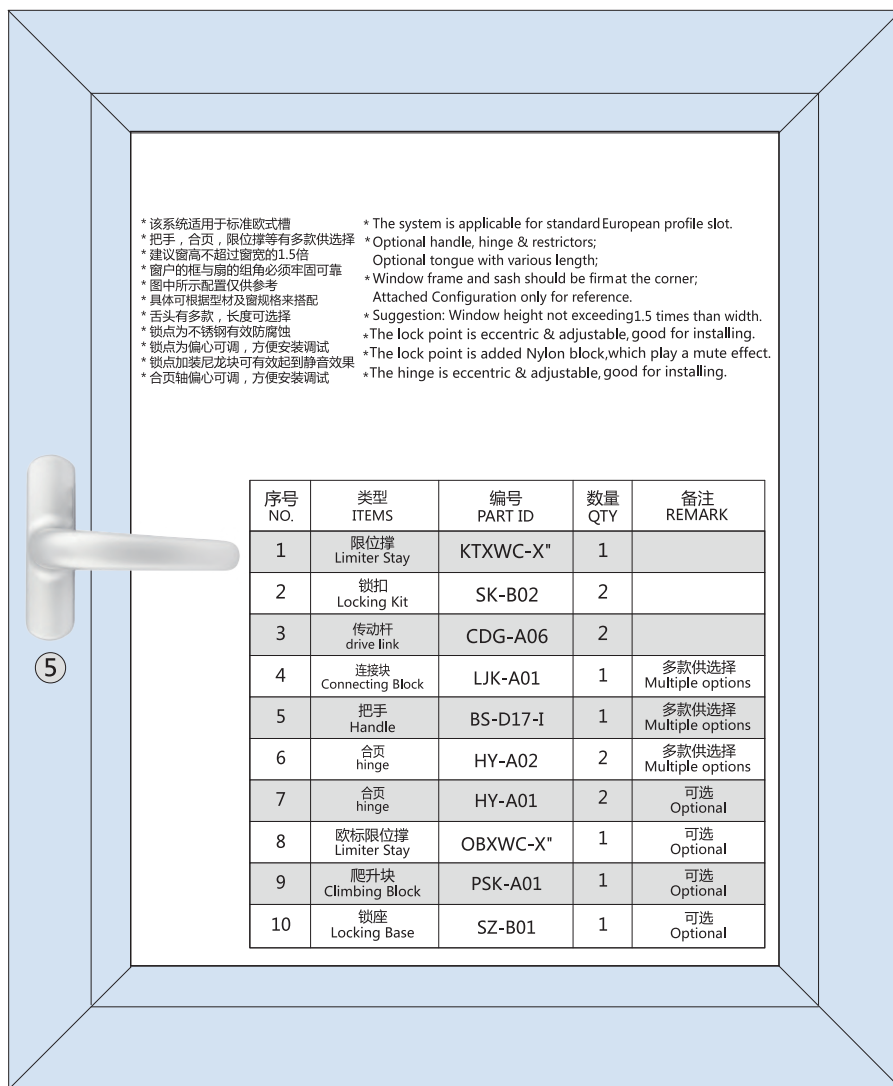
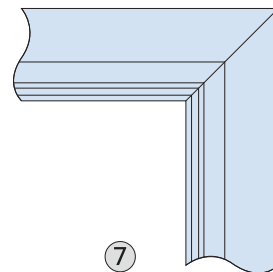
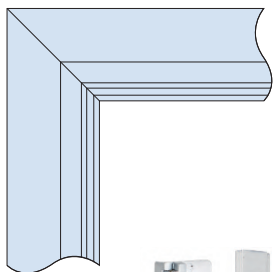
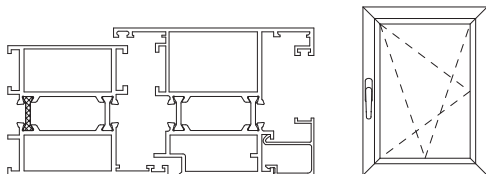

* 该系统适用于标准欧式槽
* 把手, 合页, 限位撑等有多款供选择
* 建议窗高不超过窗宽的1.5倍
* 窗户的框与扇的角必须牢固可靠
* 图中所示配置仅供参考
* 具体可根据型材及窗规格来搭配
* 舌头有多款, 长度可选择
* 锁点为不锈钢有效防腐蚀
* 锁点为偏心可调, 方便安装调试
* 锁点加装尼龙块可有效起到静音效果
* 合页轴偏心可调, 方便安装调试

* The system is applicable for standard European profile slot.
* Optional handle, hinge & restrictors;
* Optional tongue with various length;
* Window frame and sash should be firm at the corner;
* Attached Configuration only for reference.
* Suggestion: Window height not exceeding 1.5 times than width.
* The lock point is eccentric & adjustable, good for installing.
* The lock point is added Nylon block, which play a mute effect.
* The hinge is eccentric & adjustable, good for installing.

序号 NO.	类型 ITEMS	编号 PART ID	数量 QTY	备注 REMARK
1	限位撑 Limiter Stay	KTXWC-X"	1	
2	锁扣 Locking Kit	SK-B02	2	
3	传动杆 drive link	CDG-A06	2	
4	连接块 Connecting Block	LJK-A01	1	多款供选择 Multiple options
5	把手 Handle	BS-D17-I	1	多款供选择 Multiple options
6	合页 hinge	HY-A02	2	多款供选择 Multiple options
7	合页 hinge	HY-A01	2	可选 Optional
8	欧标限位撑 Limiter Stay	OBXWC-X"	1	可选 Optional
9	爬升块 Climbing Block	PSK-A01	1	可选 Optional
10	锁座 Locking Base	SZ-B01	1	可选 Optional

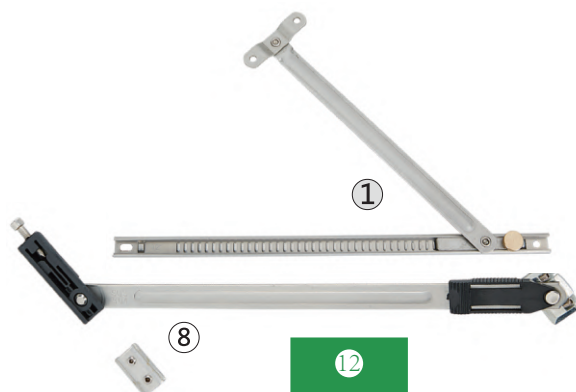
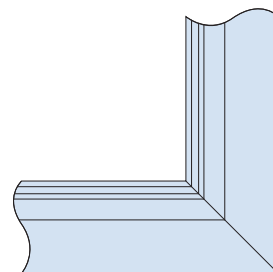
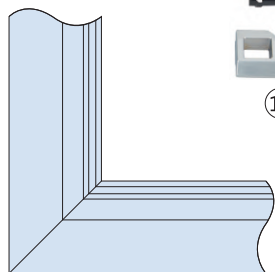

外平开五金件WPKC-02

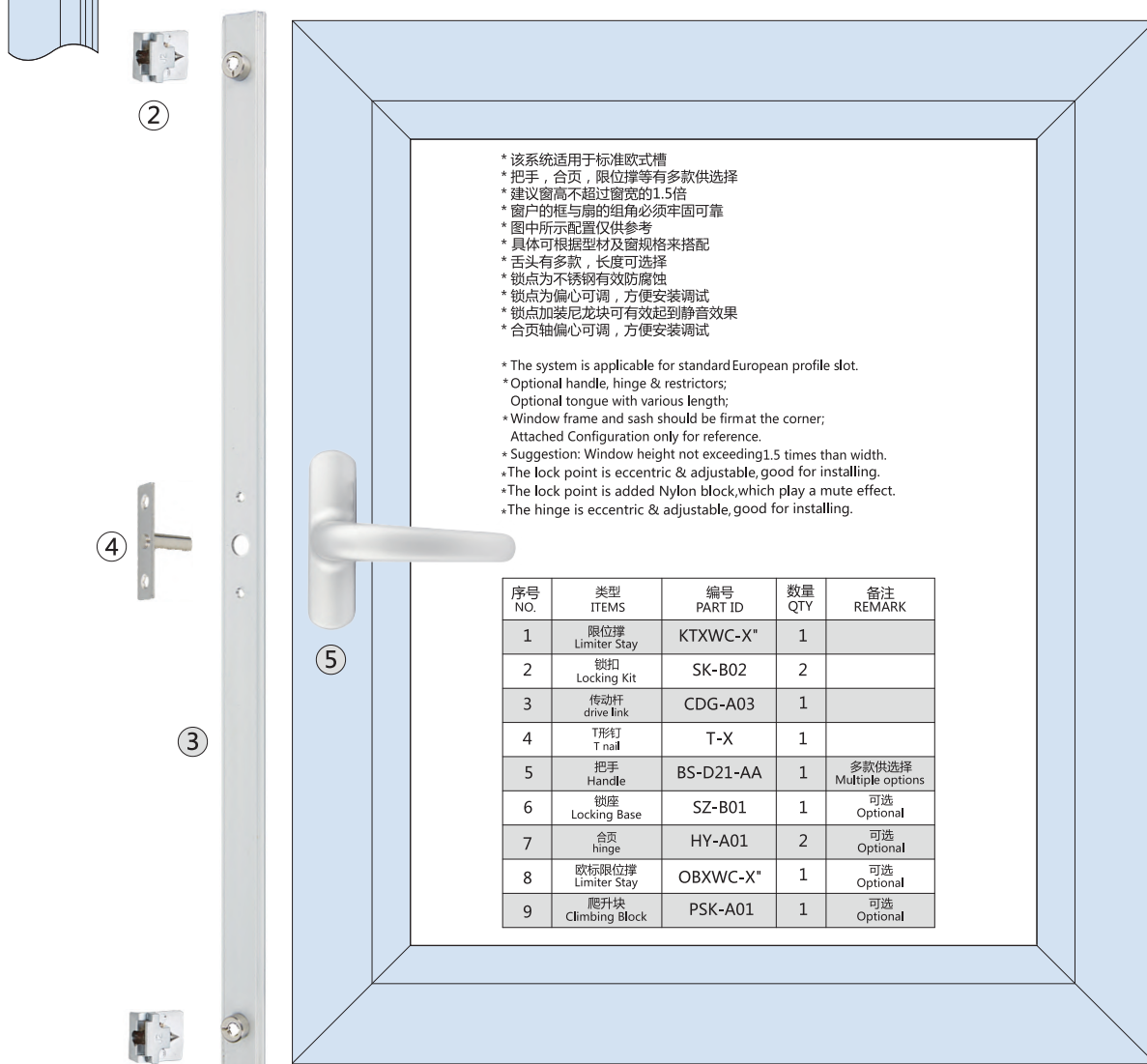
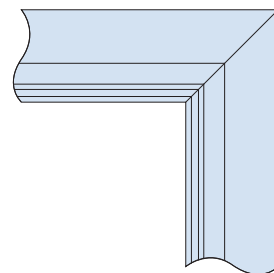
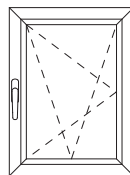
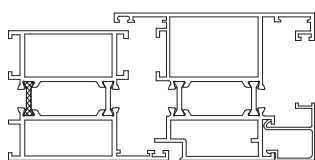
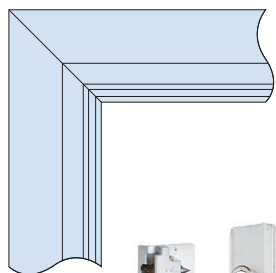

- * 该系统适用于标准欧式槽
- * 把手, 合页, 限位撑等多款供选择
- * 建议窗高不超过窗宽的1.5倍
- * 窗户的框与扇的组角必须牢固可靠
- * 图中所示配置仅供参考
- * 具体可根据型材及窗规格来搭配
- * 舌头有多款, 长度可选择
- * 锁点为不锈钢有效防腐蚀
- * 锁点为偏心可调, 方便安装调试
- * 锁点加装尼龙块可有效起到静音效果
- * 合页轴偏心可调, 方便安装调试

- * The system is applicable for standard European profile slot.
- * Optional handle, hinge & restrictors;
- * Optional tongue with various length;
- * Window frame and sash should be firm at the corner;
- * Attached Configuration only for reference.
- * Suggestion: Window height not exceeding 1.5 times than width.
- * The lock point is eccentric & adjustable, good for installing.
- * The lock point is added Nylon block, which play a mute effect.
- * The hinge is eccentric & adjustable, good for installing.

序号 NO.	类型 ITEMS	编号 PART ID	数量 QTY	备注 REMARK
1	限位撑 Limiter Stay	KTXWC-X"	1	
2	锁扣 Locking Kit	SK-B02	2	
3	传动杆 drive link	CDG-A03	1	
4	T形钉 T nail	T-X	1	
5	把手 Handle	BS-D21-AA	1	多款供选择 Multiple options
6	锁座 Locking Base	SZ-B01	1	可选 Optional
7	合页 hinge	HY-A01	2	可选 Optional
8	欧标限位撑 Limiter Stay	OBXWC-X"	1	可选 Optional
9	爬升块 Climbing Block	PSK-A01	1	可选 Optional

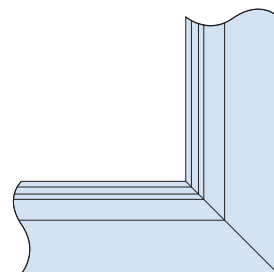
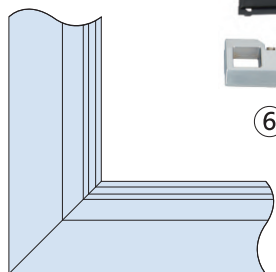

外平开五金件WPKC-03

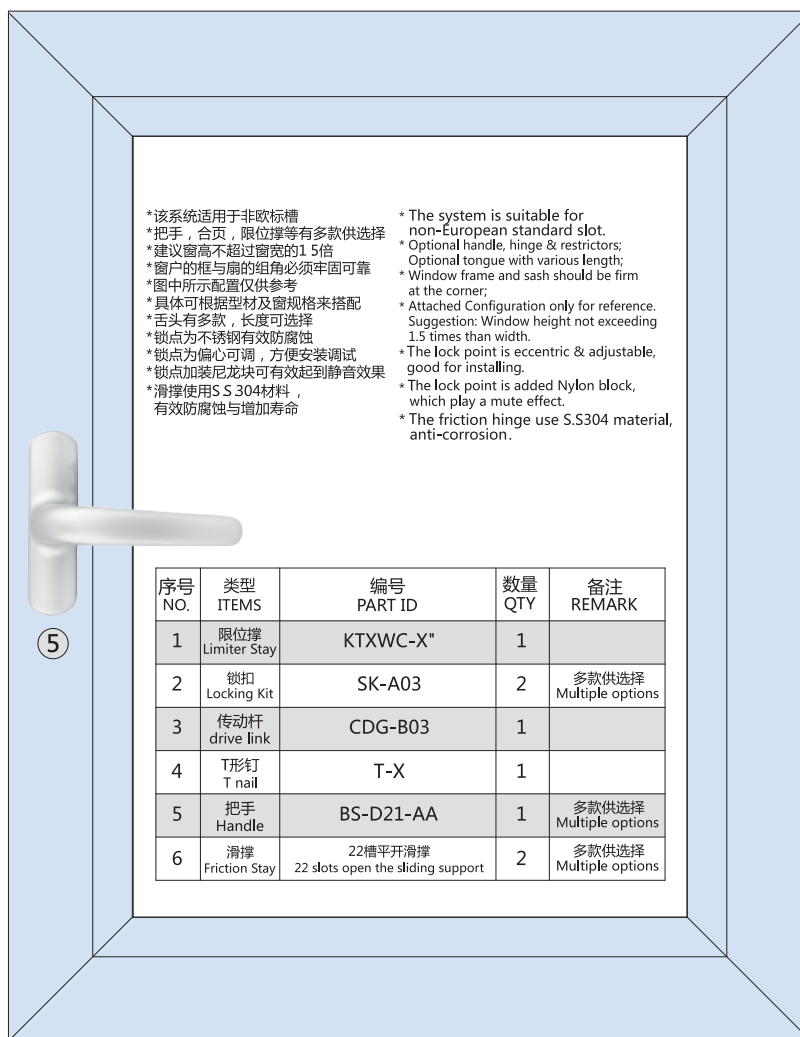
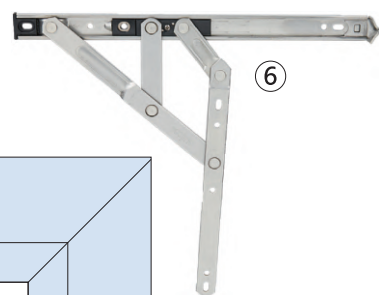
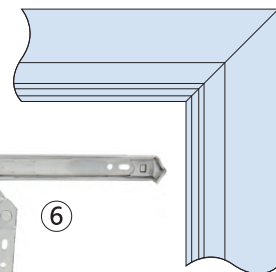
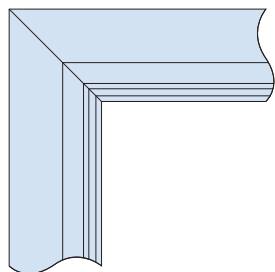
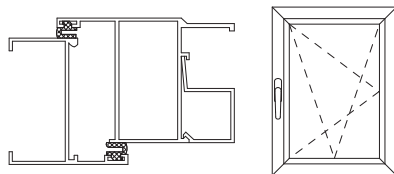

*该系统适用于非欧标准槽
*把手，合页，限位撑等多款供选择
*建议窗高不超过窗宽的1.5倍
*窗户的框与扇的组角必须牢固可靠
*图中所示配置仅供参考
*具体可根据型材及窗规格来搭配
*舌头有多款，长度可选择
*锁点为不锈钢有效防腐蚀
*锁点为偏心可调，方便安装调试
*锁点加装尼龙块可有效起到静音效果
*滑撑使用S.S304材料，有效防腐蚀与增加寿命

* The system is suitable for non-European standard slot.
* Optional handle, hinge & restrictors;
* Optional tongue with various length;
* Window frame and sash should be firm at the corner;
* Attached Configuration only for reference. Suggestion: Window height not exceeding 1.5 times than width.
* The lock point is eccentric & adjustable, good for installing.
* The lock point is added Nylon block, which play a mute effect.
* The friction hinge use S.S304 material, anti-corrosion.

序号 NO.	类型 ITEMS	编号 PART ID	数量 QTY	备注 REMARK
1	限位撑 Limiter Stay	KTXWC-X"	1	
2	锁扣 Locking Kit	SK-A03	2	多款供选择 Multiple options
3	传动杆 drive link	CDG-B03	1	
4	T形钉 T nail	T-X	1	
5	把手 Handle	BS-D21-AA	1	多款供选择 Multiple options
6	滑撑 Friction Stay	22槽平开滑撑 22 slots open the sliding support	2	多款供选择 Multiple options

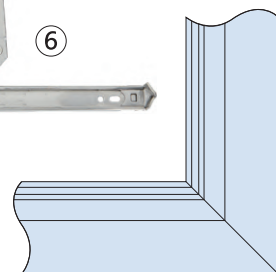
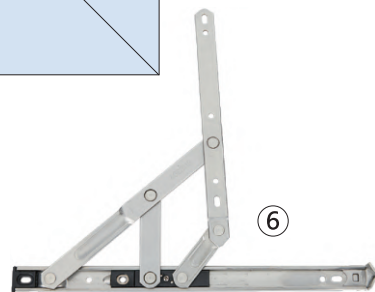
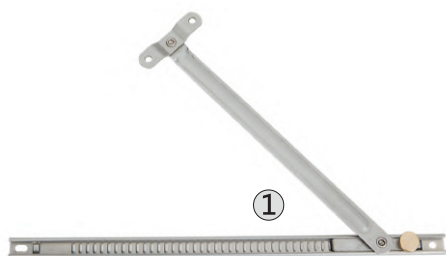
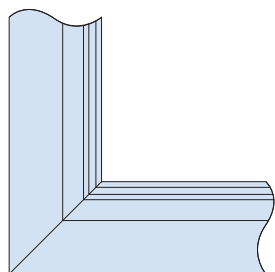

外平开五金件WPKC-04

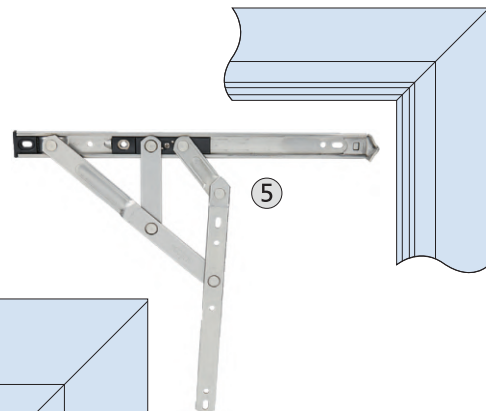
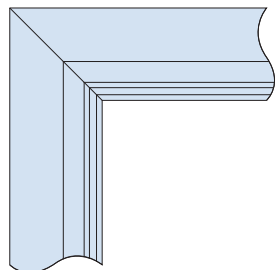
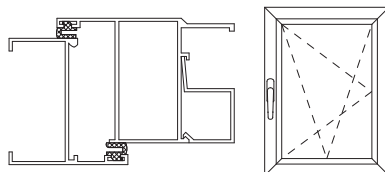

- *该系统适用于非欧标准槽
 - *把手, 合页, 限位撑等多款供选择
 - *建议窗高不超过窗宽的1.5倍
 - *窗户的框与扇的组角必须牢固可靠
 - *图中所示配置仅供参考
 - *具体可根据型材及窗规格来搭配
 - *舌头有多款, 长度可选择
 - *锁点为不锈钢有效防腐蚀
 - *锁点为偏心可调, 方便安装调试
 - *锁点加装尼龙块可有效起到静音效果
 - *滑撑使用S.S304材料, 有效防腐蚀与增加寿命
- * The system is suitable for non-European standard slot.
 - * Optional handle, hinge & restrictors;
 - * Optional tongue with various length;
 - * Window frame and sash should be firm at the corner;
 - * Attached Configuration only for reference. Suggestion: Window height not exceeding 1.5 times than width.
 - * The lock point is eccentric & adjustable, good for installing.
 - * The lock point is added Nylon block, which play a mute effect.
 - * The friction hinge use S.S304 material, anti-corrosion.

序号 NO.	类型 ITEMS	编号 PART ID	数量 QTY	备注 REMARK
1	限位撑 Limiter Stay	KTXWC-X"	1	
2	锁扣 Locking Kit	SK-A03	2	多款供选择 Multiple options
3	传动杆 drive link	CDG-B01	1	
4	把手 Handle	BS-D17-I	1	多款供选择 Multiple options
5	滑撑 Friction Stay	22槽平开滑撑 22 slots open the sliding support	2	多款供选择 Multiple options

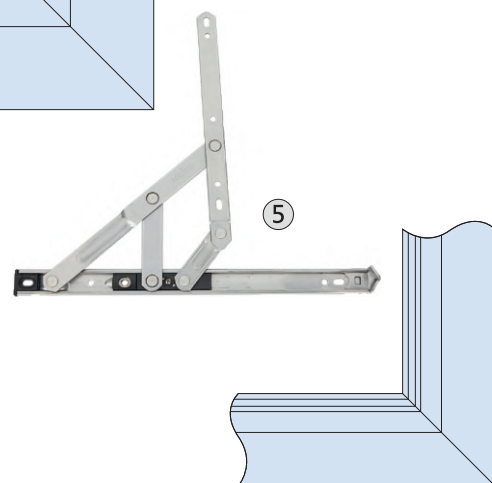
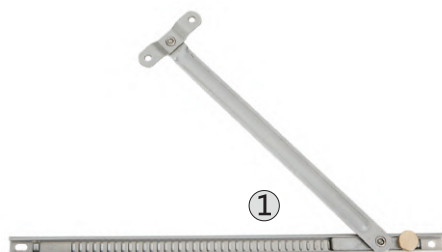
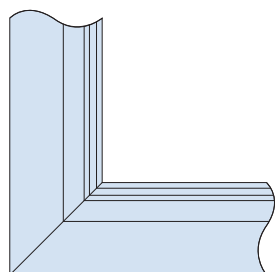

外平开五金件WPKC-05

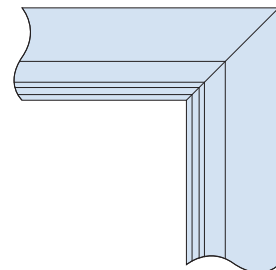
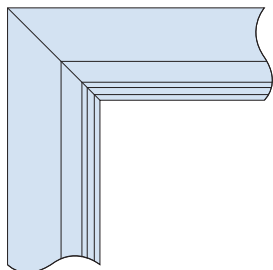
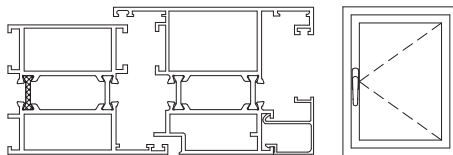

- * 该系统适用于标准欧式槽
- * 把手, 合页, 限位撑等多款供选择
- * 建议窗高不超过窗宽的1.5倍
- * 窗户的框与扇的组角必须牢固可靠
- * 图中所示配置仅供参考
- * 具体可根据型材及窗规格来搭配
- * 舌头有多款, 长度可选择
- * 锁点为不锈钢有效防腐蚀
- * 锁点为偏心可调, 方便安装调试
- * 锁点加装尼龙块可有效起到静音效果
- * 合页轴偏心可调, 方便安装调试

- * The system is applicable for standard European profile slot.
- * Optional handle, hinge & restrictors;
- * Optional tongue with various length;
- * Window frame and sash should be firm at the corner;
- * Attached Configuration only for reference.
- * Suggestion: Window height not exceeding 1.5 times than width.
- * The lock point is eccentric & adjustable, good for installing.
- * The lock point is added Nylon block, which play a mute effect.
- * The hinge is eccentric & adjustable, good for installing.

序号 NO.	类型 ITEMS	编号 PART ID	数量 QTY	备注 REMARK
1	限位撑 Limiter Stay	KTXWC-X"	1	多款供选择 Multiple options
2	锁扣 Locking Kit	SK-B02	2	
3	传动盒 Transmitter	CDH-A01	1	多款供选择 Multiple options
4	把手 Handle	BS-E15-I	1	多款供选择 Multiple options
5	合页 hinge	HY-A02	2	多款供选择 Multiple options
6	合页 hinge	HY-A01	2	可选 Optional
7	欧标限位撑 Limiter Stay	OBXWC-X"	1	可选 Optional
8	锁点 Locking Point	SD-A01	2	多款供选择 Multiple options
9	标准传动杆 Standard Transmission Rod	-	2	自备 Self-Provided

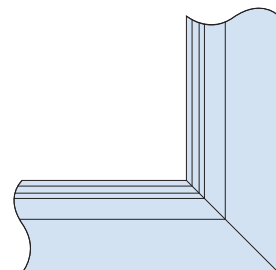
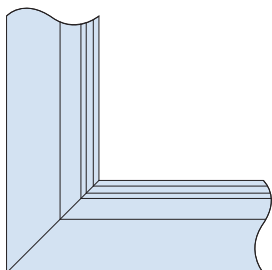

双扇平开窗系统:

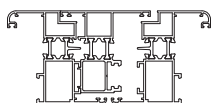

序号 NO.	类型 ITEMS	编号 PART ID	备注 REMARK	序号 NO.	类型 ITEMS	编号 PART ID	备注 REMARK
1	合页 hinge	HY-A01		5	锁点 Locking Point	SD-A08	
2	把手 Handle	BS-D26		6	锁扣 Locking Kit	SK-B07	
3	插销 latch	CX-D04		7	T形钉 T nail	LJK-A09	
4	锁座 Locking Base	SZ-B04		8	传动盒 Transmitter	CDH-B01	可选 Optional

